

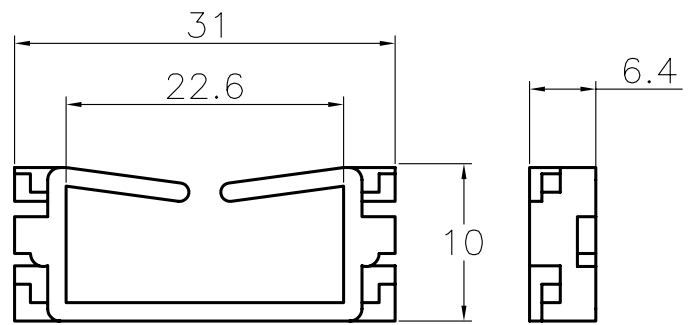

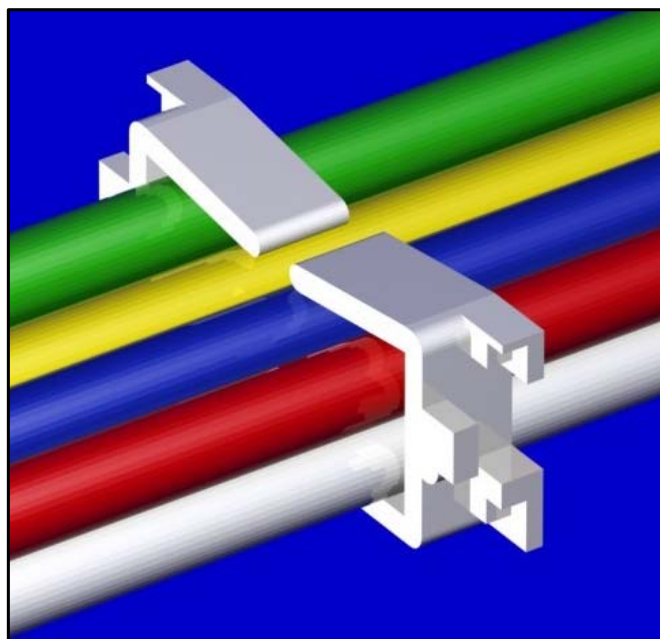

PPV-1

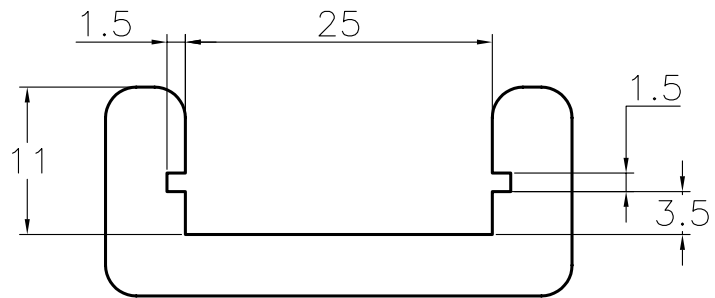
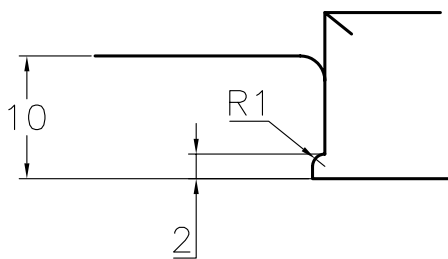

PPV-2



| | | | |
|----------------|-------|-------|-------------|
| Revision | Resp. | Date | Description |
| Revisión | | Fecha | Descripción |
| Revision | Resp. | Date | Description |
| Revisión | | Fecha | Descripción |
| Modifications | | | |
| Modificaciones | | | |

| | | | | | | | | |
|--|----------------------|-----------|----------|------------------------------|---------------|---|--|---------|
| Project | Proteccion de cables | | | Material | PA66 UL94 V2 | This drawing contains confidential information. Not allowed its reproduction total or partial <i>Este plano contiene información confidencial. Queda prohibida su distribución total o parcial</i> All dimensions in metric system Unidades en sistema métrico | | |
| Projecto | Cable protection | | | | | | | |
| Part name | PROTECTOR DE CABLES | | | | | | | |
| Denominación | CABLE PROTECTOR | | | | | | | |
| Reference | PPV | | | Finish | Liso-Flat |  Electronics Technologies Plastics | | |
| Referencia | | | | Acabado | | | | |
|  Drawn  Checked  Comprobado | Name | Signature | Date | Tolerances unless noted | Version | | | Version |
| | Nombre | Firma | Fecha | Tolerancias salvo indicación | Versión | | | Versión |
| | A.Amores | | 20/06/08 | Dimensions | Sheet size | DIN A4 | | |
| | | | | Cotas | Tamaño página | | | |
| | | | | ± 0.2 | Sheet number | | | |
| | | | | ± 0.5 | Hoja número | | | |